

# IN\_RING TUB M A 90

Code	09.0591.13.930.BK
Color	Black
Input Wattage	10.8 W
Luminaire luminous flux	1210 Lm
Luminaire efficacy	112.03 lm/W
CCT	3000K
CRI	>90
Voltage (V)	48V
Warranty	5 Years
IP Grade	IP20

## OPTICAL

Type	CREE LED
Light beam angle	50°
Light distribution	Symmetric

## ELECTRICAL

Driver	Included
Power factor	0.8
LED input Voltage (nominal)	18V
LED input Current (nominal)	600mA
Dimming	NO DIM
Electrical insulation class	Class III

## OTHER DATA

Track type	IN_RING TRACK 48V DC
Swivel angle	90°
Rotation angle	355°
Materials	Aluminium / Polycarbonate
Weight	0.21 kg
Gross weight	0.274 kg



## DIMENSIONS

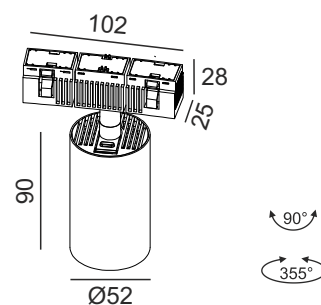

## ACCESSORY

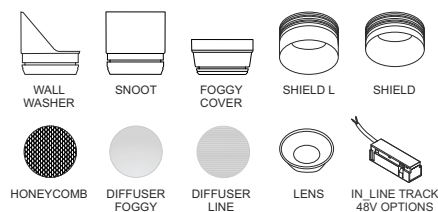

## CERTIFICATIONS



# TUB M ACCESSORY

Model WALL WASHER TUB M  
Category Accessories

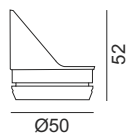

Code 06.A05WW  
Color Black

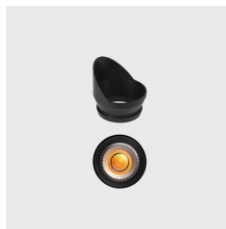

# TUB M ACCESSORY

Model SNOOT TUB M  
Category Accessories

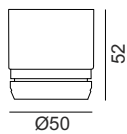

Code 06.A05NB  
Color Black

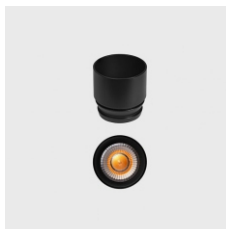

# TUB M ACCESSORY

Model FOGGY COVER TUB M  
Category Accessories

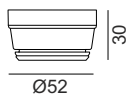

Code 06.A05FG  
Color Mat white

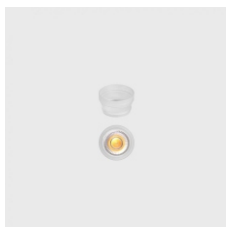

# TUB M ACCESSORY

Model SHIELD L TUB M  
 Category Accessories

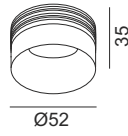

Code 06.A05SHL.BR  
 Color Brass



Code 06.A05SHL.CP  
 Color Copper

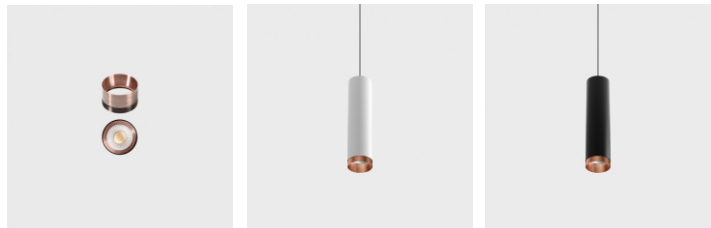

# TUB M ACCESSORY

Model SHIELD TUB M  
 Category Accessories

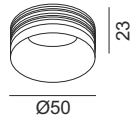

Code 06.A05SH.BR  
 Color Brass



Code 06.A05SH.CP  
 Color Copper

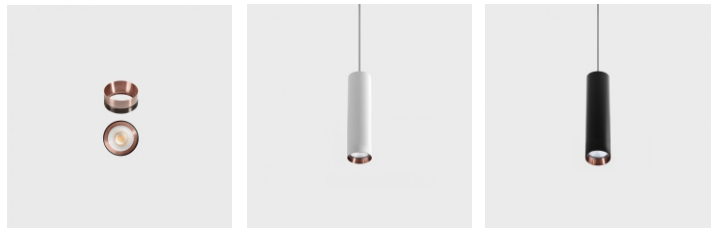

# TUB M ACCESSORY

Model HONEYCOMB TUB M  
Category Accessories

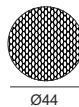

Code 06.A05HC  
Color Black

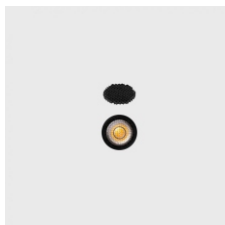

# TUB M ACCESSORY

Model DIFFUSER FOGGY TUB M  
Category Accessories



Code 06.A05SFT  
Color Foggy

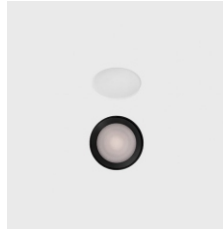



# TUB M ACCESSORY

Model DIFFUSER LINE TUB M  
Category Accessories



Code 06.A05ELPS  
Color Transparent

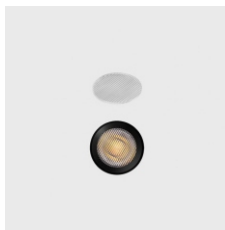

# TUB M ACCESSORY

Model LENS TUB M  
Category Accessories



Code 06.A05LS15  
Light beam angle 15°  
Color Transparent

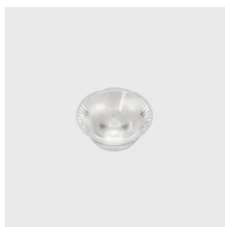

Code 06.A05LS30  
Light beam angle 30°  
Color Transparent

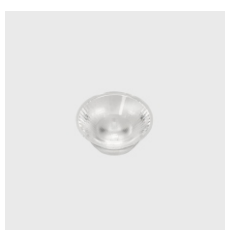

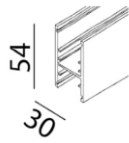
**IN\_RING 48V**

	Code	Dimensions (mm): LxWxH	Color
IN_RING 200 48V <b>2m</b> with 3 parts*	<b>06.C200.BK</b>	2000 x 30 x 54	White
IN_RING 300 48V <b>2m</b> with 3 parts*	<b>06.C200.BK</b>	2000 x 30 x 54	Black
IN_RING 500 48V <b>3m</b> with 6 parts*	<b>06.C300.WH</b>	3000 x 30 x 54	White
IN_RING 200 48V <b>3m</b> with 6 parts*	<b>06.C300.BK</b>	3000 x 30 x 54	Black
IN_RING 300 48V <b>5m</b> with 8 parts*	<b>06.C500.WH</b>	5000 x 30 x 54	White
IN_RING 500 48V <b>5m</b> with 8 parts*	<b>06.C500.BK</b>	5000 x 30 x 54	Black

\*See mounting instructions

**ALL 48V TRACK IN\_RING****IN\_RING LIVE END 600**

	Code	Dimensions (mm): LxWxH	Color
Feed cable	<b>06.CLE60.WH</b>	600	White
	<b>06.CLE60.BK</b>	600	Black

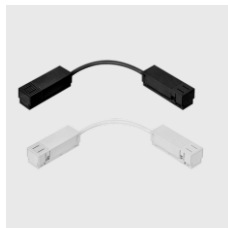

**IN\_RING ELECTRICAL JOINT FLEX**

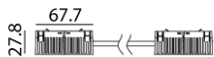
	Code	Color
Electrical joint flex connector for tack	<b>06.C2LE60.WH</b>	White
	<b>06.C2LE60.BK</b>	Black

**CERTIFICATIONS**



## ALL 48V TRACK IN\_RING

## POWER SUPPLY

	Code	Dimensions (mm): LxWxH	Power Watt	Color
	<b>PS-60-48</b>	162,5 x 42,5 x 32	60	Grey
	<b>PS-100-48</b>	190 x 52 x 37	100	Grey
	<b>PS-150-48</b>	191 x 63 x 37,5	150	Grey

CE IP67 48V ⓘ DRIVER MUST BE PLACED ON REMOTE

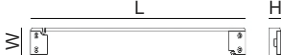
## POWER SUPPLY

	Code	Dimensions (mm): LxWxH	Power Watt	Color
	<b>06.PSU.100.W/O</b>	298 x 30 x 16,5	100	Grey
	<b>06.PSU.200.W/O</b>	384 x 30 x 22	200	Grey
	<b>06.PSU.250.W/O</b>	384 x 30 x 22	250	Grey

CE IP20 48V ⓘ DRIVER MUST BE PLACED ON REMOTE

## CERTIFICATIONS

